

Lithium Manganese Dioxide Battery

CR1616

■ Dimensions(mm)

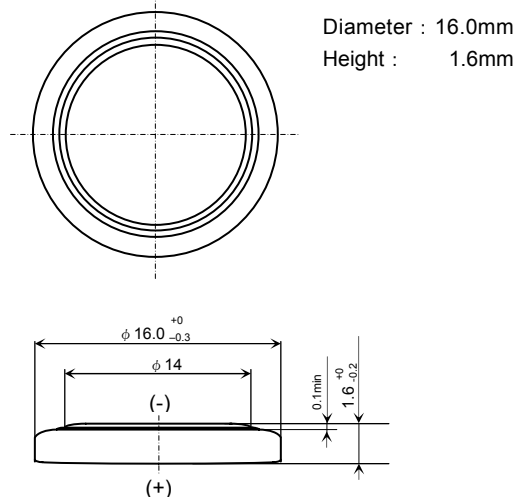

■ Specifications

Nominal Voltage	3V
Nominal Capacity (2.0V cutoff)	60mAh
Standard Discharge Current	0.1mA
Weight	1.1g

Applications

- Electronic Watch or Clock
- Electronic Calculator
- Memory Back-up Power Source for SRAM or Real Time Clock (RTC)

■ Discharge Characteristics

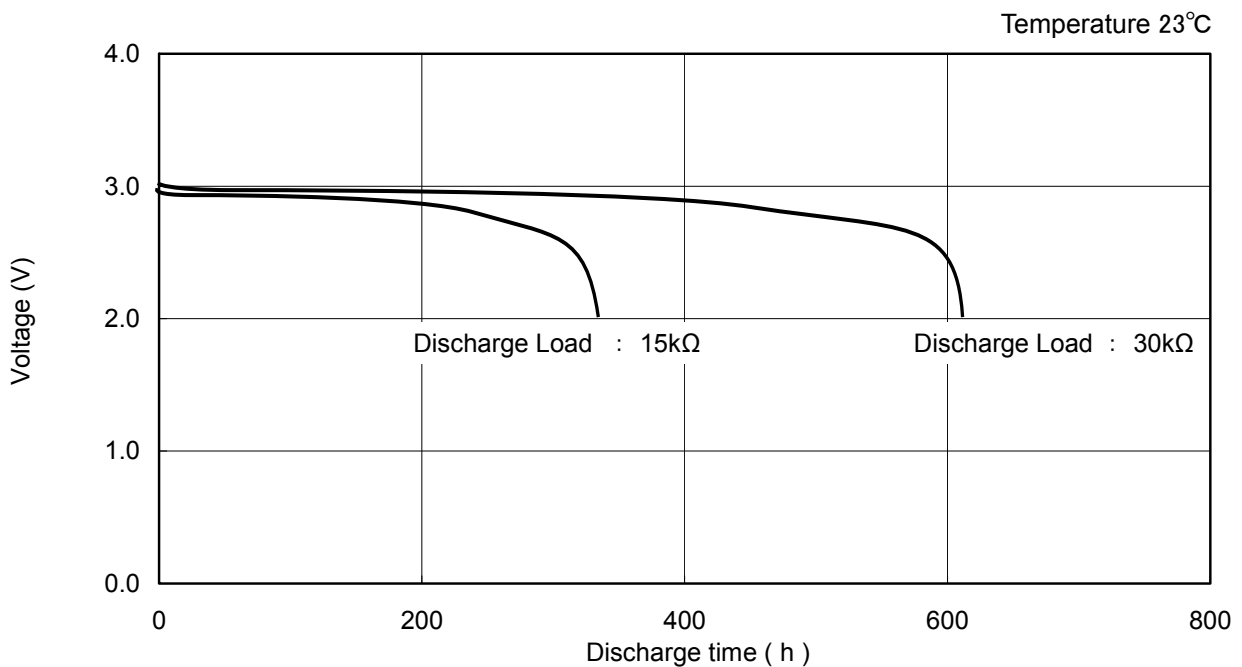

■ Discharge Characteristics on Load

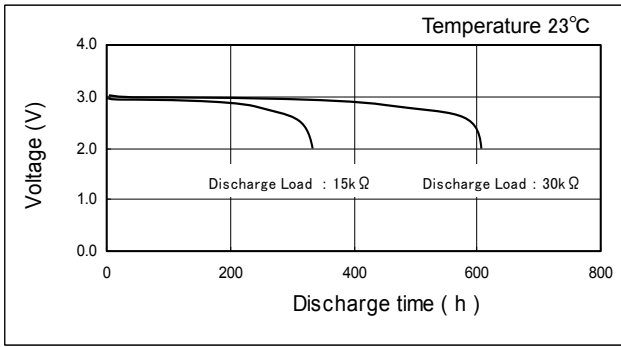

■ Discharge Characteristics on Temperature

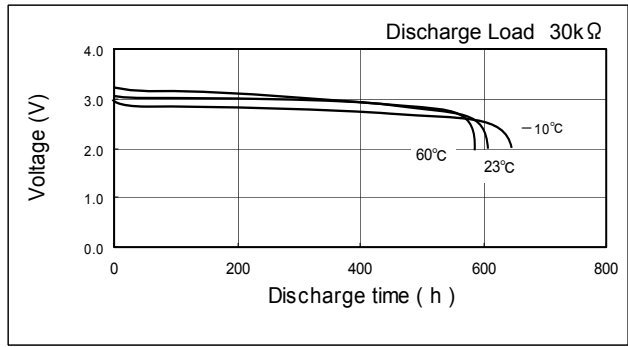

■ Discharge Load vs. Operation Voltage (Discharge depth 40%)

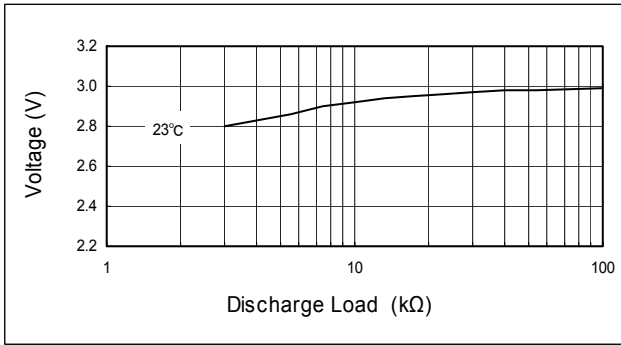

■ Discharge Load vs. Discharge Capacity

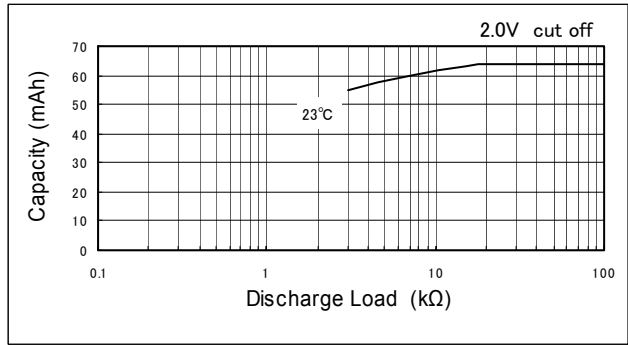

■ Discharge Characteristics on Pulse Load (Discharge depth 40%)

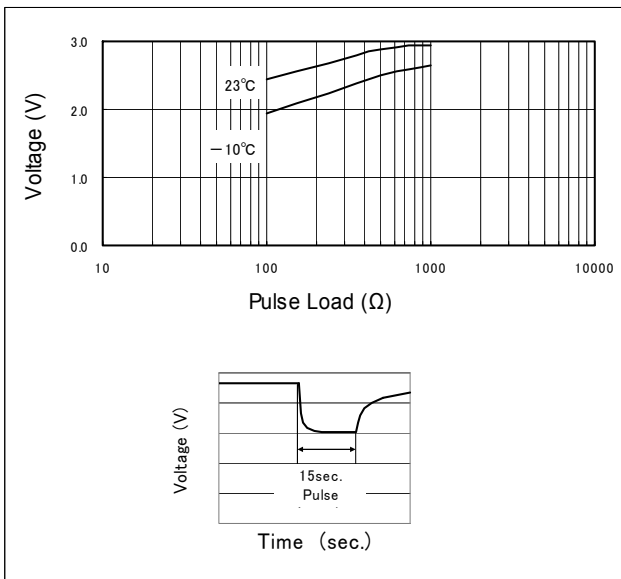

■ Storage Characteristics

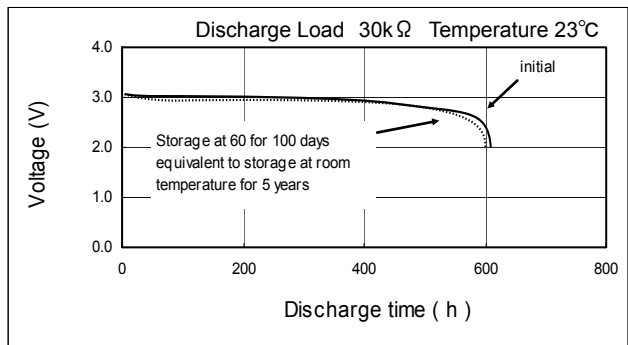

* These values are not guarantee.