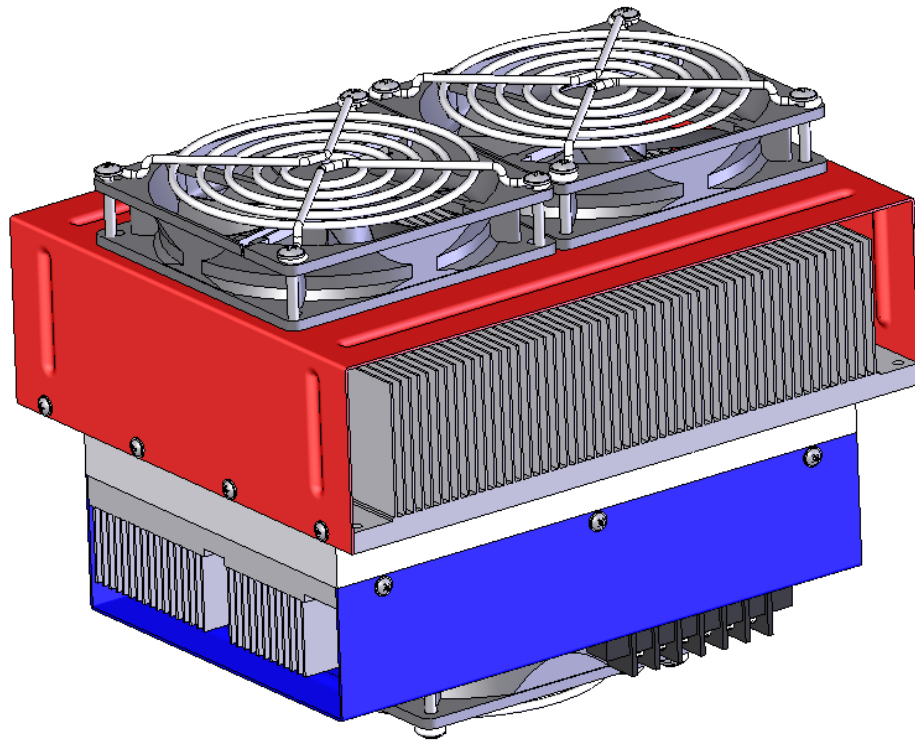

SPECIFICATION OF THERMOELECTRIC COOLING ASSEMBLY 380-24-AA ver.2

<i>Thermoelectric parameters</i>	<i>Unit</i>	<i>Value</i>
Operating voltage (U)	V	24
Operating current (I)	A	10.4
Operating cooling power (Qc)*	W	220
Tolerance	%	±10

<i>Operation parameters</i>	<i>Unit</i>	<i>Value</i>
Working temperature range	°C	-10 ÷ +70
Weight	kg	6.4

<i>Parameters of fans</i>		<i>Unit</i>	<i>Value</i>
Quantity	Hot side	-	2
	Cold side	-	1
Electrical parameters		V/A	24/0.25

*Operation cooling power corresponds to zero difference temperature between the radiator and the environment with temperature of 27°C.

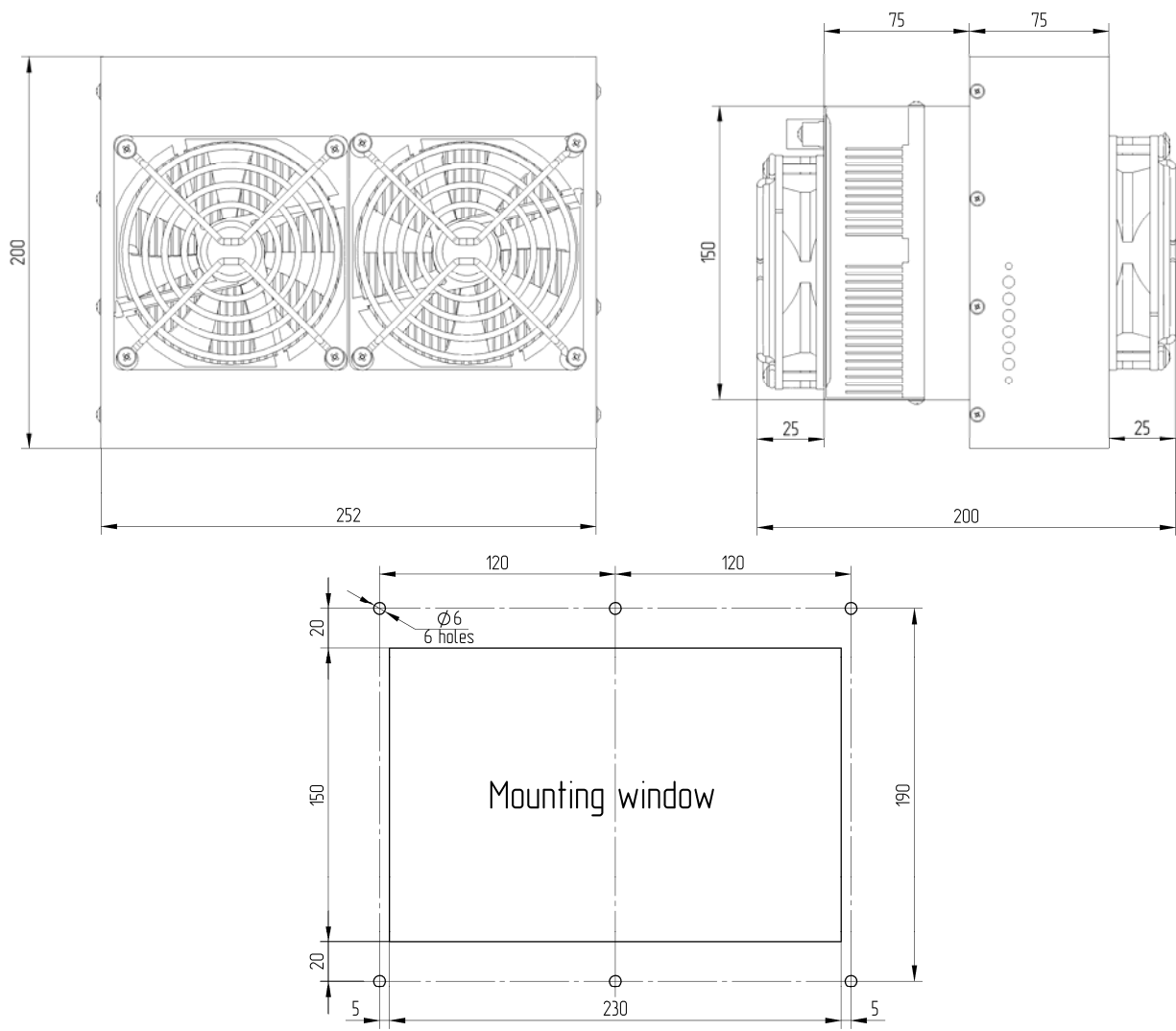

Load curve

